

Features

- One 128 x 8 (1K bit) Configuration Zone
- Eight 256 x 8 (16K bits) User Zones
- Low Voltage Operation: 2.7V to 5.5V
- Two-wire Serial Interface
- 16-byte Page Write Mode
- Self-timed Write Cycle (10 ms max)
- Answer-to-Reset Register
- High Security Memory Including Anti-wiretapping
 - 64-bit Authentication Protocol (under exclusive patent license from ELVA)
 - Authentication Attempts Counter
 - Eight Sets of Two 24-bit Passwords
 - Specific Passwords for Read and Write
 - Sixteen Password Attempts Counters
 - Selectable Access Rights by Zone
- ISO Compliant Packaging
- High Reliability
 - Endurance: 100,000 Cycles
 - Data Retention: 100 Years
 - ESD Protection: 4,000V (min)
- Low-power CMOS

Table 1. Pin Configuration

Name	Description	ISO Module Contact	Standard Package Pin
VCC	Supply Voltage	C1	8
GND	Ground	C5	1
SCL	Serial Clock Input	C3	6
SDA	Serial Data Input/Output	C7	3
RST	Reset Input	C2	7

Card Module Contact

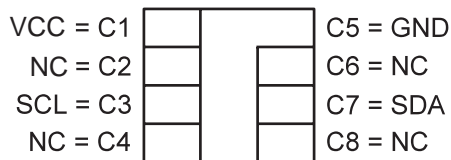

8-pin SOIC, PDIP, or LAP

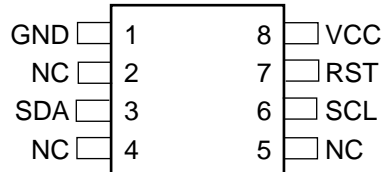

**8 x 256 x 8
Secure Memory
with
Authentication**

AT88SC1608



Description

The AT88SC1608 provides 17,408 bits of serial EEPROM memory organized as one configuration zone of 128 bytes and eight user zones of 256 bytes each. This device is optimized as a “secure memory” for the smart card market, secure identification for electronic data transfer, or components in a system, without the requirement of an internal microprocessor.

The embedded authentication protocol allows the memory and the host to authenticate each other. When this device is used with a host which incorporates a microcontroller (e.g., AT89C51, AT89C2051, AT90S1200), the system provides an “anti-wiretapping” configuration. The device and the host exchange “challenges” issued from a random generator and verify their values through a specific cryptographic function included in each part. When both agree on the same result, the access to the memory is permitted.

Figure 1. Security Methodology

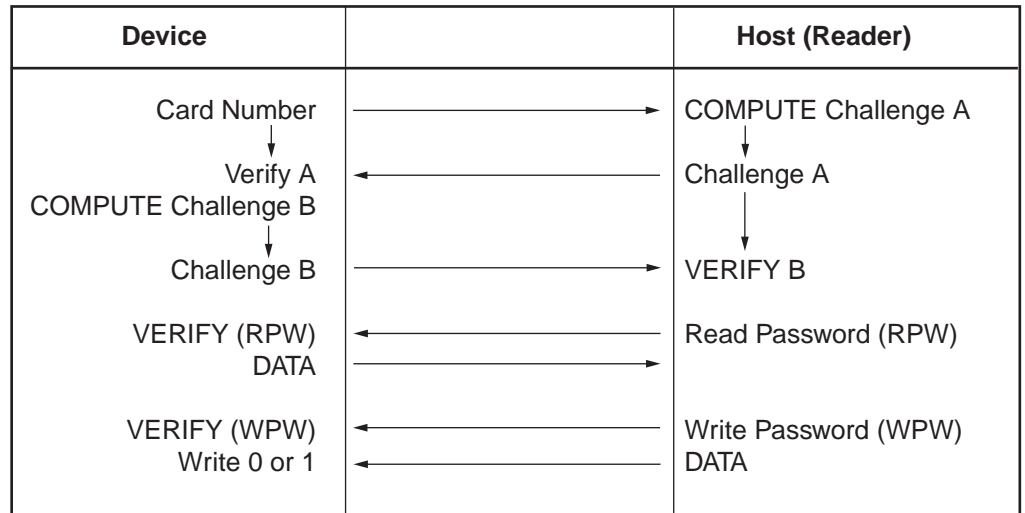

Memory Access

Depending on the device configuration, the host might carry out the authentication protocol and/or present different passwords for each operation, read or write. Each user zone may be configured for free access for read and write or for password-restricted access. To insure security between the different user zones (multiapplication card), each zone can use a different set of passwords. A specific AAC for each password and for the authentication provides protection against “systematic attacks.” When the memory is unlocked, the two-wire serial protocol is effective, using SDA and SCL. The memory includes a specific register providing a 32-bit data stream conforming to the ISO 7816-10 synchronous answer-to-reset.

Figure 2. Block Diagram

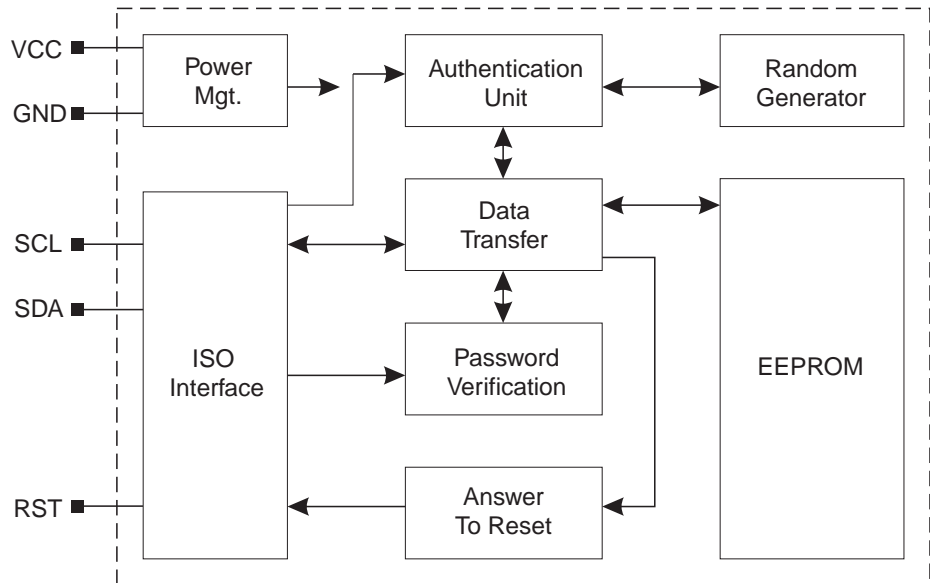

Pin Descriptions

Supply Voltage (VCC)

The V_{CC} input is a 2.7V-to-5.5V positive voltage, supplied by the host.

Serial Clock (SCL)

The SCL input is used to positive edge clock data into the device and negative edge clock data out of the device.

Serial Data (SDA)

The SDA pin is bidirectional for serial data transfer. This pin is open-drain driven and may be wire-ORed with any number of other open drain or open collector devices. An external pull-up resistor should be connected between SDA and VCC. The value of this resistor and the system capacitance loading the SDA bus will determine the rise time of SDA. This rise time will determine the maximum frequency during read operations. Low value pull-up resistors will allow higher frequency operations while drawing higher average power supply current.

Reset (RST)

When the RST input is pulsed high, the device will output the data programmed into the 32-bit answer-to-reset register. All password and authentication access will be reset. Following a reset, device authentication and password verification sequences must be presented to re-establish user access.



Memory Mapping

The first 16K bits of the memory are divided into eight user zones of 256 bytes each.

Table 1. Memory Map

Zone	\$0	\$1	\$2	\$3	\$4	\$5	\$6	\$7	
User 0									\$000
	256 bytes								-
									-
									\$0F8
User 1 - - User 6									\$000
									-
									-
									-
User 7									\$0F8
	256 bytes								-
									-
									\$0F8

Note: "\$" = hexadecimal value

The last 1K bit of the memory is a configuration zone with specific system data, access rights, and read/write commands; it is divided into six subzones.

Table 2. Configuration Zone

Configuration	\$0	\$1	\$2	\$3	\$4	\$5	\$6	\$7	
Fabrication	Answer-to-Reset				Lot History Code				\$00
	Fab Code		Reserved		Card Manufacturer Code				\$08
Access	AR0	AR1	AR2	AR3	AR4	AR5	AR6	AR7	\$10
	Reserved for Future Use								\$18
Authentication	AAC	Identification Number (Nc)						\$20	
	Cryptogram (Ci)								\$28
Secret	Secret Seed (Gc)								\$30
Test	Reserved for Memory Test								\$38
Passwords	PAC	Write 0			PAC	Read 0			\$40
	PAC	Write 1			PAC	Read 1			\$48
	PAC	Write 2			PAC	Read 2			\$50
	PAC	Write 3			PAC	Read 3			\$58
	PAC	Write 4			PAC	Read 4			\$60
	PAC	Write 5			PAC	Read 5			\$68
	PAC	Write 6			PAC	Read 6			\$70
	PAC	Secure Code/Write 7			PAC	Read 7			\$78

Note: AAC: Authentication Attempts Counter
PAC: Password Attempts Counter
AR0-7: Access Register for User Zone 0 to 7

Fuses

FAB, CMA, and PER are nonvolatile fuses blown at the end of each card life step. Once blown, these EEPROM fuses can not be reset.

- The FAB fuse is blown by Atmel prior to shipping wafers to the card manufacturer.
- The CMA fuse is blown by the card manufacturer prior to shipping cards to the issuer.
- The PER fuse is blown by the issuer prior to shipping cards to the end user.

The fuses are read and written in the configuration zone using the address \$80.

Table 3. Fuse Byte

Bit 7	Bit 6	Bit 5	Bit 4	Bit 3	Bit 2	Bit 1	Bit 0	
0	0	0	0	0	PER	CMA	FAB	\$80



When the fuses are all “1”s, read and write are allowed in the entire memory. Before blowing the FAB fuse, Atmel writes the entire memory to “1”, except the fabrication sub-zone and the secure code.

Figure 3. Access Rights

Zone	Access	FAB = 0	CMA = 0	PER = 0
Fabrication (Except CMC)	Read	Free	Free	Free
	Write	Forbidden	Forbidden	Forbidden
Fabrication (Only CMC)	Read	Free	Free	Free
	Write	Secure Code	Forbidden	Forbidden
Access	Read	Free	Free	Free
	Write	Secure Code	Secure Code	Forbidden
Authentication	Read	Free	Free	Free
	Write	Secure Code	Secure Code	Forbidden
Secret	Read	Secure Code	Secure Code	Forbidden
	Write	Secure Code	Secure Code	Forbidden
Test	Read	Free	Free	Free
	Write	Free	Free	Free
Passwords	Read	Secure Code	Secure Code	Write PW
	Write	Secure Code	Secure Code	Write PW
PAC	Read	Free	Free	Free
	Write	Secure Code	Secure Code	Write PW
User Zones	Read	AR	AR	AR
	Write	AR	AR	AR

Note: CMC = Card Manufacturer Code
 AR = Access Rights as defined by the access register
 PW = Password

Configuration Zone

- **Answer-to-reset:** 32-bit register defined by Atmel
- **Lot History Code:** 32-bit register defined by Atmel
- **Fab Code:** 16-bit register defined by Atmel
- **Card Manufacturer Code:** 32-bit register defined by the card manufacturer
- **Access Registers**

Eight 8-bit access registers defined by the issuer (enable if “0”). The access register for each user zone will specify the privileges and requirements for access to that zone.

Table 4. Access Registers

Bit 7	Bit 6	Bit 5	Bit 4	Bit 3	Bit 2	Bit 1	Bit 0
WPE	RPE	ATE	PW2	PW1	PW0	MDF	PGO

- **Write Password Enable (WPE)**

If enabled (WPE = “0”), the user is required to verify the write password to allow write operations in the user zone. If disabled (WPE = “1”), all write operations are allowed within the zone. Verification of the write password also allows the read and write passwords to be changed. During personalization (PER = “1”) the WPE bit is forced active even if set to “1”. This forces the issuer to verify the write password in order to write data to the user zone. This allows the security code (Write 7 password) to lock write functions during transportation.

- **Read Password Enable (RPE)**

If enabled (RPE = “0”), the user is required to verify either the read password or write password to allow read operations in the user zone. Read operations initiated without a verified password will return the status of the fuse bits (\$00). Verification of the write password will always allow read access to the zone. RPE = “0” and WPE = “1” is allowed but is not recommended.

- **Authentication Enable (ATE)**

If enabled (ATE = “0”), a valid authentication sequence must be completed before access is allowed to the user zone. If disabled (ATE = “1”), authentication is not required for access.

- **Password Set Select (PW2, PW1, PW0)**

These three bits define which of the eight password sets must be presented to allow access to the user zone. Each access register may point to a unique password set, or access registers for multiple zones may point to the same password set. In this case, verification of a single password will open several zones, combining the zones into a single larger zone.

- **Modify Forbidden (MDF)**

If enabled (MDF = “0”), no write access is allowed in the zone at any time.

- **Program Only (PGO)**

If enabled (PGO = “0”), data within the zone may be changed from “1” to “0” but never from “0” to “1”.

Identification Number (Nc)

An identification number with up to 56 bits is defined by the issuer and should be unique for each card.

Cryptogram (Ci)

The 64-bit cryptogram is generated by the internal random generator and modified after each successful verification of the cryptogram by the chip, on host request. The initial value, defined by the issuer, is diversified as a function of the identification number.

Secret Seed (Gc)

The 64-bit secret seed, defined by the issuer, is diversified as a function of the identification number.

Memory Test Zone

The memory test zone is a 64-bit free access zone for memory test.

Password Sets

The password sets are eight sets of two 24-bit passwords for read and write operations, defined by the issuer. The write password allows the user to modify the read and write passwords of the same set. By default, the eighth set of passwords (Write 7/Read 7) is active for all user zones.

- **Secure Code**

A 24-bit password, defined by Atmel, that is different for each card manufacturer. The Write Password 7 is used as the secure code until the personalization is over (PER = 0).

- **Attempts Counters**

There are 16 8-bit password attempts counters (PACs), one for each password, and one other 8-bit attempts counter for the authentication protocol (AAC). The attempts counters limit the number of consecutive incorrect code presentations allowed (currently eight).

User Zones

These zones are dedicated to user data. The access rights of each zone are programmable separately via the access registers. If several zones share the same password set, the set will be entered only once (after the part is powered up). Therefore, several zones can be combined into one larger zone. The user zone address should be changed each time a new zone is being reached.

Security Operations

Password Verification

Compare the operation password presented with the stored one and write a new bit in the corresponding attempts counter for each wrong attempt. A valid attempt before the limit erases the attempts counter, and allows the operation to be carried out as long as the chip is powered.

Only one password is active at a time. When a new password is presented, access privileges defined by the previous password become invalid.

If the trials limit has been reached (i.e., the 8 bits of the attempts counter have been written), the password verification process will not be taken into account.

Authentication Protocol

The access to a user zone may be protected by an authentication protocol in addition to password-dependent rights.

The authentication success is memorized and active as long as the chip is powered, unless a new authentication is initialized or RST becomes active. If the new authentication request is not validated, the card has lost its previous authentication and it should be presented again. Only the last request is memorized.

The authentication verification protocol requires the host to perform an Initialize Authentication command, followed by a Verify Authentication command.

The password and authentication may be presented at any time and in any order. If the trials limit has been reached, i.e., the 8 bits of the attempts counter have been written, the password verification or authentication process will not be taken into account.

Command Definitions and Protocols

The communications protocol is based on the popular two-wire serial interface. Note that the most significant bit is transmitted first.

Table 5. Device Commands

Description	Code HEX	Command							
		Chip Select				Instruction			
		b7	b6	b5	b4	b3	b2	b1	b0
Write User Zone	\$B0	1	0	1	1	0	0	0	0
Read User Zone	\$B1	1	0	1	1	0	0	0	1
Write Configuration Zone	\$B4	1	0	1	1	0	1	0	0
Read Configuration Zone	\$B5	1	0	1	1	0	1	0	1
Set User Zone Address	\$B2	1	0	1	1	0	0	1	0
Verify Password	\$B3	1	0	1	1	0	0	1	1
Initialize Authentication	\$B6	1	0	1	1	0	1	1	0
Verify Authentication	\$B7	1	0	1	1	0	1	1	1

Set User Zone Address

Figure 4. Set User Zone Address

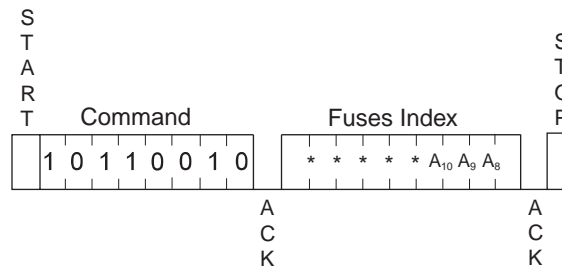

Note: * = Don't care bit

At power-on, no access to the user zones is allowed until the *Set User Zone Address* command occurs. This command sets the three most significant bits of the byte address, corresponding to the user zone address. This address stays valid until the host sends a new one and as long as the chip is powered.

Read Zone

Figure 5. Read Zone

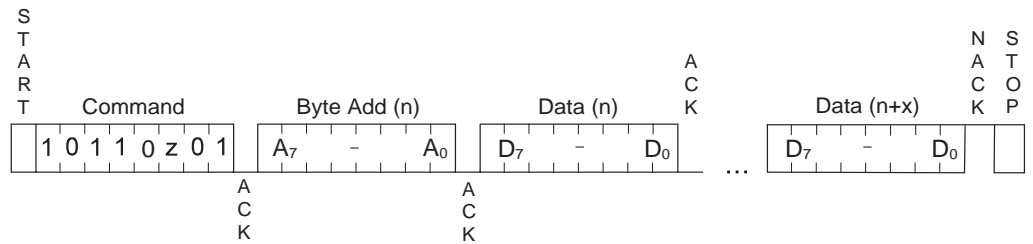

Note: z = 0: Read user zone
z = 1: Read configuration zone

The data byte address is internally incremented following the transmission of each data byte. As long as the AT88SC1608 receives an acknowledge from the host, it will continue to increment the data byte address and serially clock out sequential data bytes. During a read operation, the address will “roll over” from the last byte of the current zone to the first byte of the same zone. If the host is not allowed to read at the specified address, the device will transmit the data byte with all bits equal to “0”.

Write Zone

Figure 6. Write Zone

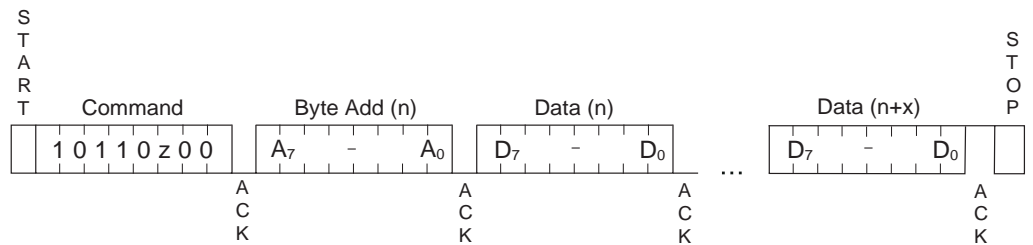

Note: z = 0: Write user zone
z = 1: Write configuration zone

The lower four bits of the data byte address are internally incremented following the receipt of each data byte. The higher data byte address bits are not incremented, retaining the 16-byte write-page address. Each data byte within a page must only be loaded once. Once a stop condition is issued to indicate the end of the host’s write command, the device initiates the internally timed nonvolatile write cycle. An ACK polling sequence can be initiated immediately. After a write command, if the host is not allowed to write to some address locations, a nonvolatile write cycle will still be initiated. However, the device will only modify data at the allowed addresses.

Read Fuses

Figure 7. Read Fuses

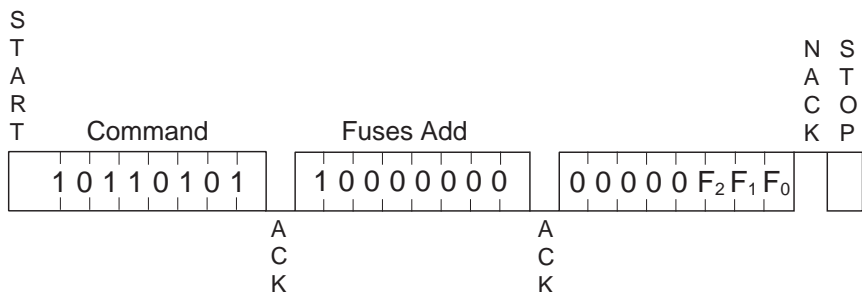

Note: F_x = 1: fuse is not blown
F_x = 0: fuse is blown

The read fuses operation is always allowed. The device only transmits one data byte and waits for a new command.

Write Fuses

Figure 8. Write Fuses

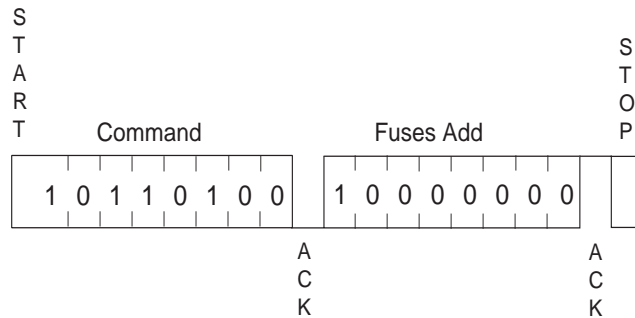

The write fuses operation is only allowed under secure code control and no data byte is transmitted by the host. The fuses are blown sequentially: CMA is blown if FAB is equal to “0”, and PER is blown if CMA is equal to “0”. If the fuses are all “0”s, the operation is canceled and the device waits for a new command.

Once a stop condition is issued to indicate the end of the host’s write operation, the device initiates the internal nonvolatile write cycle. An ACK polling sequence can be initiated immediately. Once blown, these fuses cannot be reset.

Answer-to-reset

If RST is high during SCL clock pulse, the reset operation occurs according to the ISO 7816-10 synchronous answer-to-reset. The four bytes of the answer-to-reset register are transmitted least significant bit (LSB) first on the 32 clock pulses provided on SCL. Following a RST assertion, all password and authentication access privileges are reset.

The values programmed by Atmel are shown in Figure 9 below.

Figure 9. Answer-to-reset

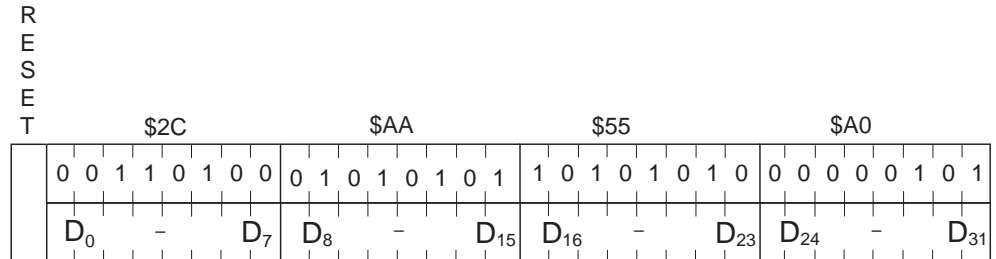

Verify Password

Figure 10. Verify Password

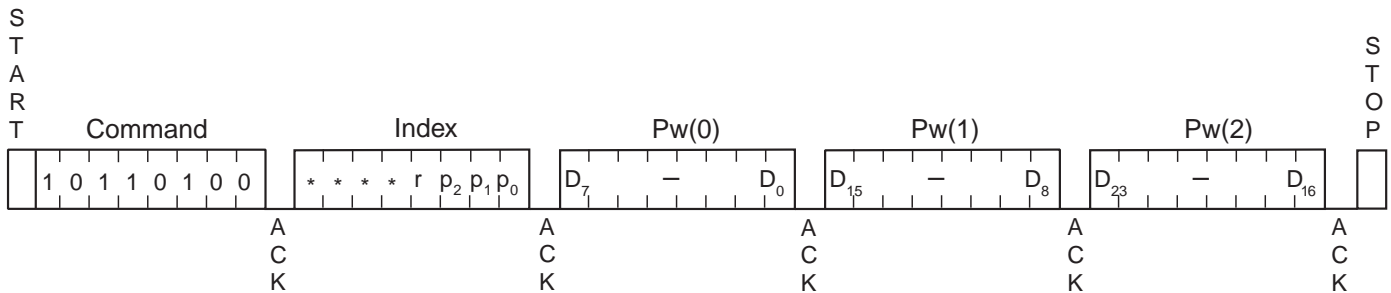

1. Pw: Password, 3 bytes
2. The four bits "rppp" indicate the password to compare:
 - r = 0: Write password
 - r = 1: Read password
 - ppp: Password set number
 - (rppp = 0111 for the secure code)

Once the sequence is completed and a stop condition is issued, there is a nonvolatile write cycle to update the associated attempts counter. In order to know whether or not the inserted password was correct, the device requires the host to perform an ACK polling sequence with the specific device address of \$B5. When the write cycle has been completed, the ACK polling command (\$B5, Read Configuration Zone) will return a valid ACK. This command should be followed by the byte address of the respective PAC. If the password presented is valid, the PAC will be set to \$FF. If the password was not valid, the PAC will have one additional bit written to "0".

Initialize Authentication

Figure 11. Initialize Authentication

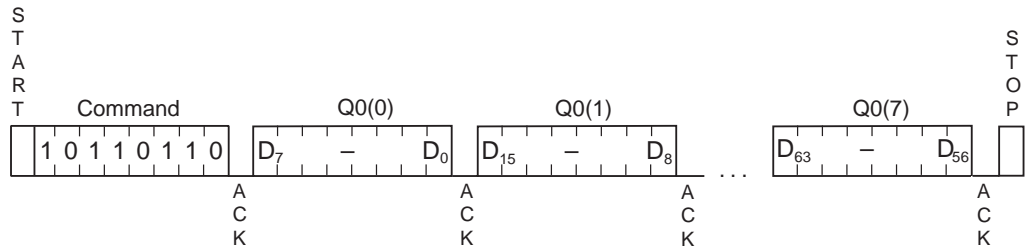

Note: Q0: Host random number, 8 bytes

The initialize authentication command sets up the random generator with the cryptogram (Ci), the secret seed (Gc), and the host random number (Q0). Once the sequence is completed and a stop condition is issued, there is a nonvolatile write cycle to write a new bit of the 8-bit AAC to "0". In order to complete the authentication protocol, the device requires the host to perform an ACK polling sequence with the specific device address of \$B7, corresponding to the verify authentication command.

Verify Authentication

Figure 12. Verify Authentication

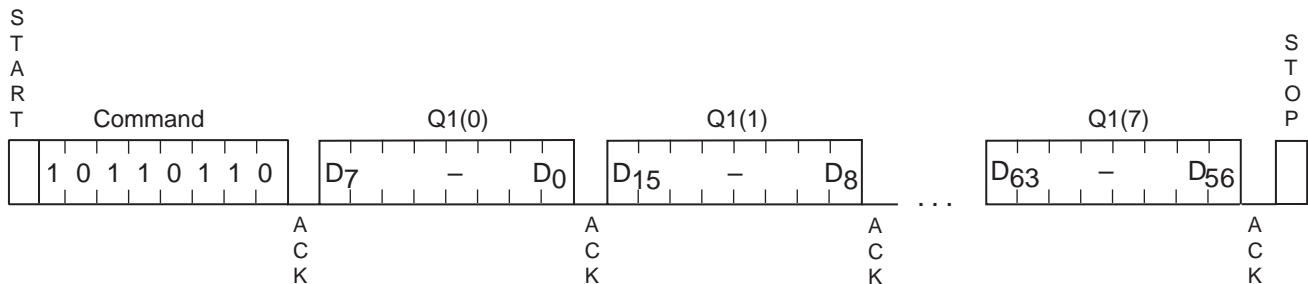

Note: Q1: Host challenge, 8 bytes

If Q1 is equal to Ci + 1, then the device writes Ci + 2 in memory in place of Ci; this must be preceded by the initialize authentication command. Once the sequence is completed and a stop condition is issued, there is a nonvolatile write cycle to update the associated attempts counter. In order to know whether or not the authentication was correct, the device requires the host to perform an ACK polling sequence with the specific device address of \$B5 to read the AAC in the configuration zone. A valid authentication will result in the AAC cleared to \$FF. An invalid authentication attempt will initiate a nonvolatile write cycle, but no clear operation will be performed on the AAC.

Device Operation

Clock and Data Transitions

The SDA pin is normally pulled high with an external device. Data on the SDA pin may change only during SCL-low time periods (see Figure 14). Data changes during SCL-high time periods will indicate a start or stop condition as defined below.

Start Condition

A high-to-low transition of SDA with SCL high is a start condition which must precede any other command (see Figure 13).

Stop Condition

A low-to-high transition of SDA with SCL high is a stop condition. After a read sequence, the stop command will place the device in a standby power mode (see Figure 13).

Acknowledge

All addresses and data are serially transmitted to and from the device in 8-bit words. The device sends a zero to acknowledge that it has received each byte. This happens during the ninth clock cycle. During read operations, the host must pull the SDA line low during the ninth clock cycle to acknowledge that it has received the data byte. Failure to transmit this ACK bit will terminate the read operation.

Standby Mode

The AT88SC1608 features a low-power standby mode that is enabled upon power-up and after the receipt of the stop bit and the completion of any internal operations.

Acknowledge Polling

Once the internally-timed write cycle has started and the device inputs are disabled, acknowledge polling can be initiated. This involves sending a start condition followed by the device address representative of the operation desired. Only if the internal write cycle has completed will the device respond with a "0", allowing the sequence to continue.

Figure 13. Start and Stop Definition

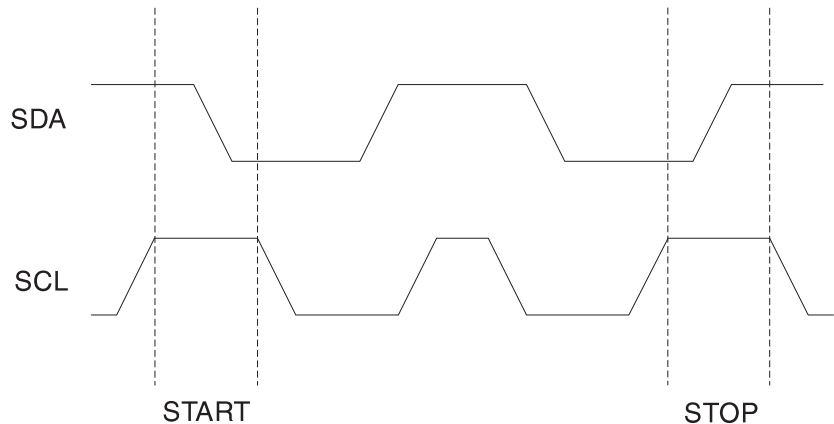

Note: The SCL input should be low when the device is idle. Therefore, SCL is low before a start condition and after a stop condition.

Figure 14. Data Validity

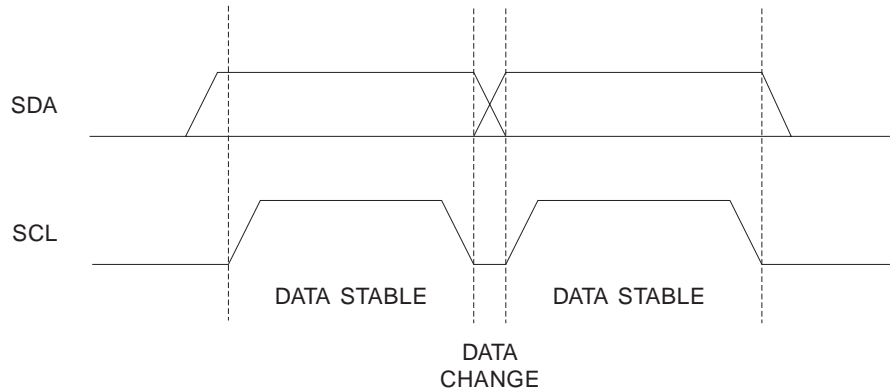
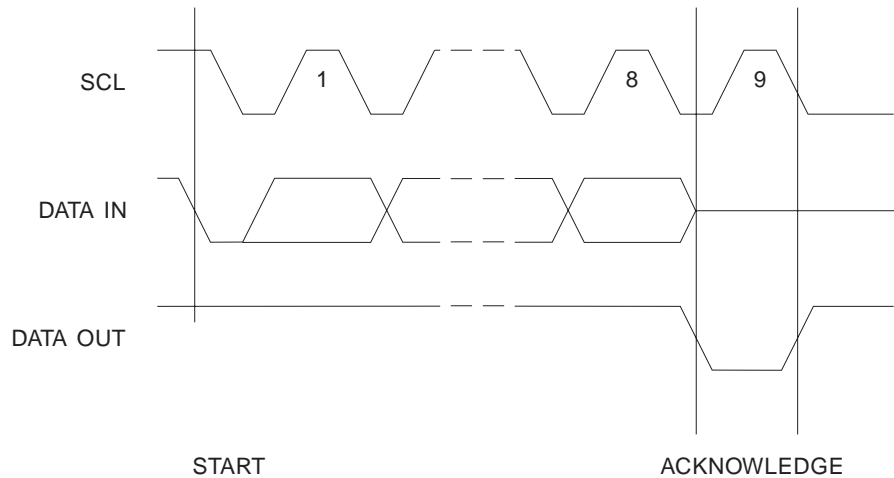

Figure 15. Output Acknowledge



Absolute Maximum Ratings

Operating Temperature -55° C to +125° C	<p>Note: Stresses beyond those listed under “Absolute Maximum Ratings” may cause permanent damage to the device. This is a stress rating only; functional operation of the device at these or any other conditions beyond those indicated in the operational sections of this specification is not implied. Exposure to absolute maximum rating conditions for extended periods may affect device reliability.</p>
Storage Temperature -65° C to +150° C	
Voltage on Any Pin with Respect to Ground -0.7V to $V_{CC} + 0.7V$	
Maximum Operating Voltage 6.25V	
DC Output Current 5.0 mA	

DC Characteristics

Table 6. DC Characteristics

Applicable over recommended operating range from: $V_{CC} = +2.7V$ to $5.5V$, $T_{AC} = 0^{\circ}C$ to $+70^{\circ}C$. (unless otherwise noted).

Symbol	Parameter	Test Condition	Min	Typ	Max	Units
$V_{CC}^{(1)}$	Supply Voltage		2.7		5.5	V
I_{CC}	Supply Current $V_{CC} = 5.0V$	Read at 1 MHz			5.0	mA
I_{CC}	Supply Current $V_{CC} = 5.0V$	Write at 1 MHz			5.0	mA
$I_{SB1}^{(1)}$	Standby Current $V_{CC} = 2.7V$	$V_{IN} = V_{CC}$ or GND			1.0	μA
I_{SB2}	Standby Current $V_{CC} = 5.0V$	$V_{IN} = V_{CC}$ or GND			20.0	μA
I_{LI}	Input Leakage Current	$V_{IN} = V_{CC}$ or GND			1.0	μA
I_{LI}	RST Input Leakage Current	$V_{IN} = V_{CC}$ or GND			20.0	μA
I_{LO}	Output Leakage Current	$V_{OUT} = V_{CC}$ or GND			1.0	μA
V_{IL}	Input Low Level ⁽²⁾		-0.3		$V_{CC} \times 0.3$	V
V_{IH}	Input High Level ⁽²⁾		$V_{CC} \times 0.7$		$V_{CC} + 0.5$	V
V_{OL2}	Output Low Level $V_{CC} = 2.7V$	$I_{OL} = 2.1$ mA			0.4	V

Notes: 1. This parameter is preliminary; Atmel may change the specifications upon further characterization.

2. V_{IL} min and V_{IH} max are reference only and are not tested.

Power Management

If VCC falls below 1.9V, the chip stops working until it rises above 2.7V.

AC Characteristics

Table 7. AC Characteristics⁽¹⁾

Symbol	Parameter	5.0-volt		Units
		Min	Max	
f _{SCL}	Clock Frequency, SCL		1.0	MHz
t _{LOW}	Clock Pulse Width Low	400		ns
t _{HIGH}	Clock Pulse Width High	400		ns
t _{AA}	Clock Low to Data Out Valid		550	ns
t _{HD.STA}	Start Hold Time	200		ns
t _{SU.STA}	Start Set-up Time	200		ns
t _{HD.DAT}	Data In Hold Time	10		ns
t _{SU.DAT}	Data In Set-up Time	100		ns
t _R	Inputs Rise Time ⁽²⁾		100	ns
t _F	Inputs Fall Time ⁽²⁾		30	ns
t _{SU.STO}	Stop Set-up Time	200		ns
t _{DH}	Data Out Hold Time	20		ns
t _{WR}	Write Cycle Time		10	ms
t _{RST}	Reset Width High	600		ns
t _{SU.RST}	Reset Set-up Time	50		ns
t _{HD.RST}	Reset Hold Time	50		ns
t _{VCC-RST}	Power-on Reset Time		2.0	ms

- Note: 1. Applicable over recommended operating range from T_A = 0° C to +70° C, V_{CC} = +2.7V to +5.5V, CL = 1 TTL Gate and 100 pF (unless otherwise noted)
 2. This parameter is characterized and is not 100% tested.

Pin Capacitance

Table 8. Pin Capacitance⁽¹⁾

Symbol	Test Condition	Max	Units	Conditions
C _{I/O}	Input/Output Capacitance (SDA) ⁽²⁾	8	pF	V _{I/O} = 0V
C _{IN}	Input Capacitance (RST, SCL) ⁽²⁾	6	pF	V _{IN} = 0V

- Notes: 1. Applicable over recommended operating conditions T_A = 25° C, f = 1.0 MHz, V_{CC} = +2.7V
 2. This parameter is characterized and is not 100% tested.

Timing Diagrams

Figure 16. Bus Timing

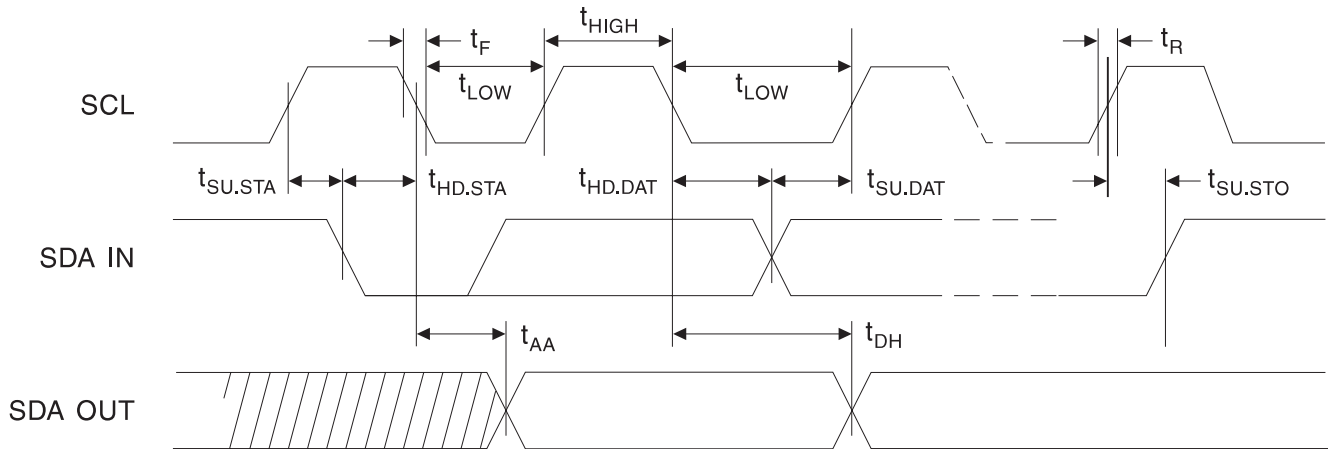

Note: SCL: Serial Clock; SDA: Serial Data I/O

Figure 17. Synchronous Answer-to-reset Timing

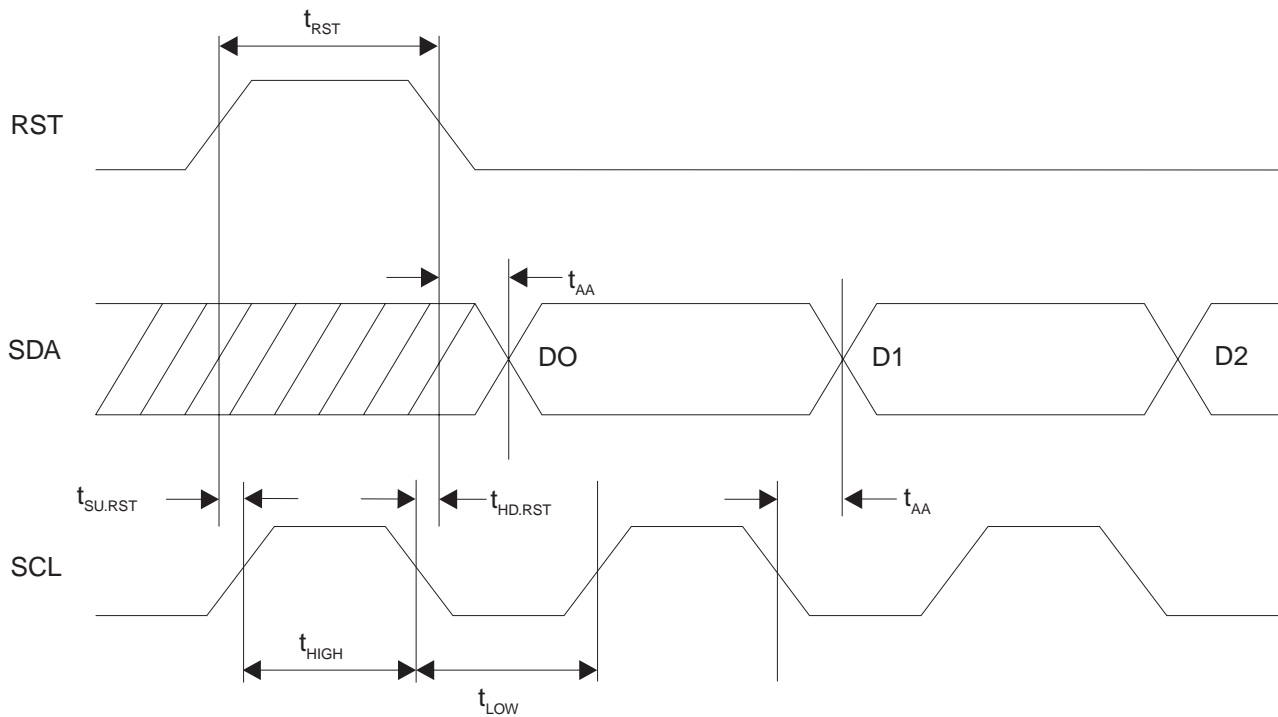
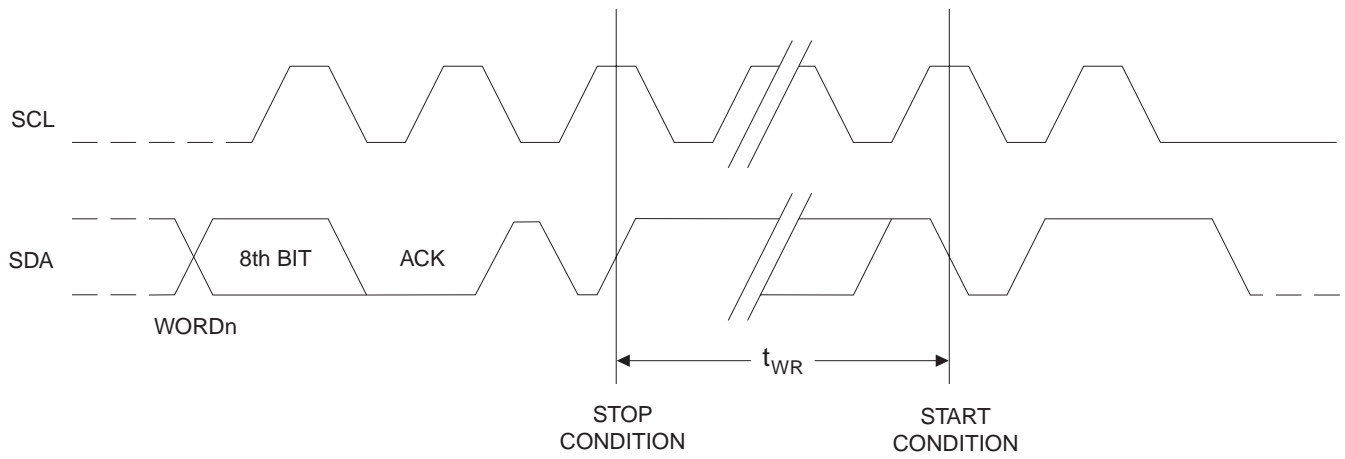

Figure 18. Write Cycle Timing



Note: The write cycle Time t_{WR} is the time from valid stop condition of a write sequence to the end of the internal clear/write cycle.

SCL: Serial Clock

SDA: Serial Data I/O



Ordering Information

Ordering Code	Package	Voltage Range	Temperature Range
AT88SC1608-09ET-00	M2 – E Module	2.7V–5.5V	Commerical (0°C–70°C)
AT88SC1608-09PT-00	M2 – P Module	2.7V–5.5V	Commerical (0°C–70°C)
AT88SC1608-10PI-00	8P3	2.7V–5.5V	Industrial (-40°C–85°C)
AT88SC1608-10SI-00	8SI	2.7V–5.5V	Industrial (-40°C–85°C)
AT88SC1608-10CI-00	8C	2.7V–5.5V	Industrial (-40°C–85°C)
AT88SC1608-10WI-00	7 mil Wafer	2.7V–5.5V	Industrial (-40°C–85°C)

Package Type ⁽¹⁾	Description
M4 – E Module	M4 ISO 7816 Smart Card Module
M4 – P Module	M4 ISO 7816 Smart Card Module with Atmel Logo
8S1	8-lead, 0.150" Wide, Plastic Gull Wing Small Outline Package (JEDEC SOIC)
8P3	8-lead, 0.300" Wide, Plastic Dual Inline Package (PDIP)
8C	8-lead, 0.230" Wide, Leadless Array Package (LAP)

Note: 1. Formal drawings may be obtained from an Atmel sales office.

Smart Card Modules

Ordering Code: 09ET-00

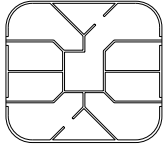

Module Size: **M2**
 Dimension*: 12.6 x 11.4 [mm]
 Glob Top: Round: Ø 8.0 [mm] max
 Thickness: 0.58 [mm] max
 Pitch: 14.25 [mm]

Ordering Code: 09PT-00

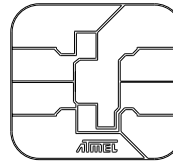

Module Size: **M2**
 Dimension*: 12.6 x 11.4 [mm]
 Glob Top: Square: 8.8 x 8.8 [mm]
 Thickness: 0.58 [mm]
 Pitch: 14.25 [mm]

*Note: The module dimensions listed refer to the dimensions of the exposed metal contact area. The actual dimensions of the module after excise or punching from the carrier tape are generally 0.4 mm greater in both directions (i.e., a punched M2 module will yield 13.0 x 11.8 mm).

Packaging Information

Ordering Code: 10SI-00
8-lead SOIC

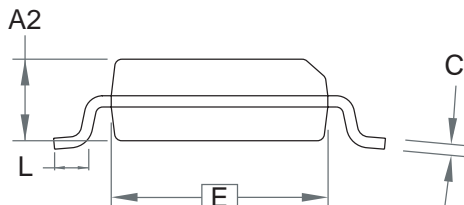
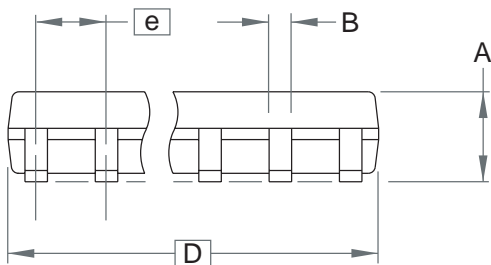
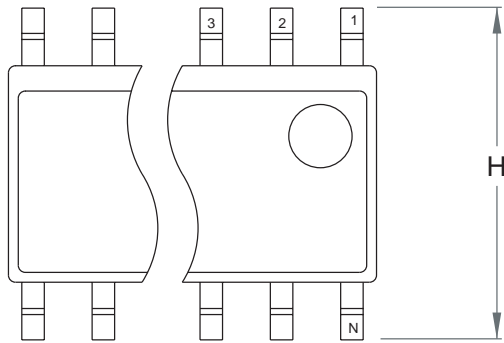

COMMON DIMENSIONS
(Unit of Measure = mm)

SYMBOL	MIN	NOM	MAX	NOTE
A	-	-	1.75	
B	-	-	0.51	
C	-	-	0.25	
D	-	-	5.00	
E	-	-	4.00	
e	1.27 BSC			
H	-	-	6.20	
L	-	-	1.27	

Note: These drawings are for general information only. Refer to JEDEC Drawing MS-012 for proper dimensions, tolerances, datums, etc.

10/10/01



2325 Orchard Parkway
San Jose, CA 95131

TITLE
8S1, 8-lead (0.150" Wide Body), Plastic Gull Wing
Small Outline (JEDEC SOIC)

DRAWING NO.
8S1

REV.
A

Ordering Code: 10PI-00
8-lead PDIP

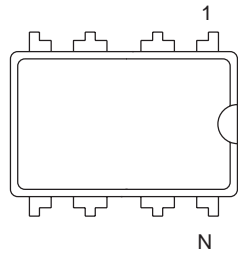

Top View

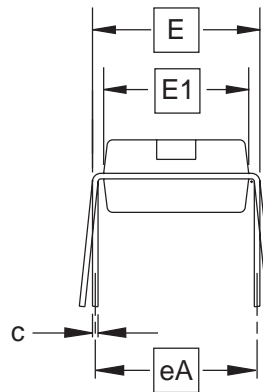

End View

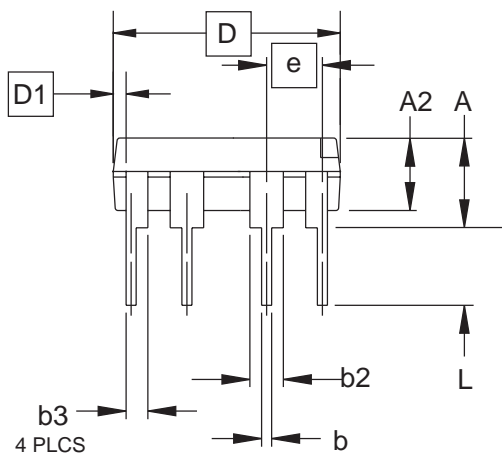

Side View

COMMON DIMENSIONS
(Unit of Measure = inches)

SYMBOL	MIN	NOM	MAX	NOTE
A	–	–	0.210	2
A2	0.115	0.130	0.195	
b	0.014	0.018	0.022	5
b2	0.045	0.060	0.070	6
b3	0.030	0.039	0.045	6
c	0.008	0.010	0.014	
D	0.355	0.365	0.400	3
D1	0.005	–	–	3
E	0.300	0.310	0.325	4
E1	0.240	0.250	0.280	3
e	0.100 BSC			
eA	0.300 BSC			4
L	0.115	0.130	0.150	2

- Notes:
1. This drawing is for general information only; refer to JEDEC Drawing MS-001, Variation BA, for additional information.
 2. Dimensions A and L are measured with the package seated in JEDEC seating plane Gauge GS-3.
 3. D, D1 and E1 dimensions do not include mold Flash or protrusions. Mold Flash or protrusions shall not exceed 0.010 inch.
 4. E and eA measured with the leads constrained to be perpendicular to datum.
 5. Pointed or rounded lead tips are preferred to ease insertion.
 6. b2 and b3 maximum dimensions do not include Dambar protrusions. Dambar protrusions shall not exceed 0.010 (0.25 mm).

01/09/02



2325 Orchard Parkway
San Jose, CA 95131

TITLE

8P3, 8-lead, 0.300" Wide Body, Plastic Dual
In-line Package (PDIP)

DRAWING NO.

8P3

REV.

B



Ordering Code: 10CI-00
8-lead LAP

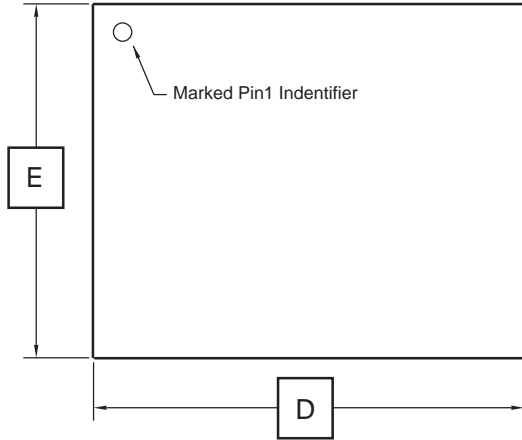

Top View

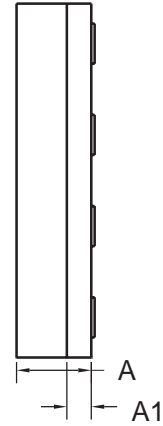

Side View

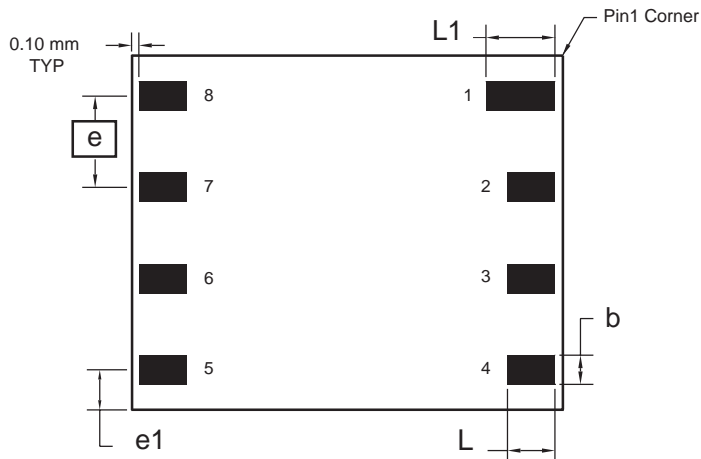

Bottom View

COMMON DIMENSIONS
 (Unit of Measure = mm)

SYMBOL	MIN	NOM	MAX	NOTE
A	0.94	1.04	1.14	
A1	0.30	0.34	0.38	
b	0.36	0.41	0.46	1
D	7.90	8.00	8.10	
E	4.90	5.00	5.10	
e	1.27 BSC			
e1	0.60 REF			
L	0.62	.0.67	0.72	1
L1	0.92	0.97	1.02	1

Note: 1. Metal Pad Dimensions.

11/13/01



2325 Orchard Parkway
 San Jose, CA 95131

TITLE
8CN1, 8-lead (8 x 5 x 1.04 mm Body), Lead Pitch 1.27 mm,
 Leadless Array Package (LAP)

DRAWING NO.
 8CN1

REV.
 A



Atmel Corporation

2325 Orchard Parkway
San Jose, CA 95131
Tel: 1(408) 441-0311
Fax: 1(408) 487-2600

Regional Headquarters

Europe

Atmel Sarl
Route des Arsenalux 41
Case Postale 80
CH-1705 Fribourg
Switzerland
Tel: (41) 26-426-5555
Fax: (41) 26-426-5500

Asia

Room 1219
Chinachem Golden Plaza
77 Mody Road Tsimshatsui
East Kowloon
Hong Kong
Tel: (852) 2721-9778
Fax: (852) 2722-1369

Japan

9F, Tonetsu Shinkawa Bldg.
1-24-8 Shinkawa
Chuo-ku, Tokyo 104-0033
Japan
Tel: (81) 3-3523-3551
Fax: (81) 3-3523-7581

Atmel Operations

Memory

2325 Orchard Parkway
San Jose, CA 95131
Tel: 1(408) 441-0311
Fax: 1(408) 436-4314

Microcontrollers

2325 Orchard Parkway
San Jose, CA 95131
Tel: 1(408) 441-0311
Fax: 1(408) 436-4314

La Chantrierie

BP 70602
44306 Nantes Cedex 3, France
Tel: (33) 2-40-18-18-18
Fax: (33) 2-40-18-19-60

ASIC/ASSP/Smart Cards

Zone Industrielle
13106 Rousset Cedex, France
Tel: (33) 4-42-53-60-00
Fax: (33) 4-42-53-60-01

1150 East Cheyenne Mtn. Blvd.
Colorado Springs, CO 80906
Tel: 1(719) 576-3300
Fax: 1(719) 540-1759

Scottish Enterprise Technology Park
Maxwell Building
East Kilbride G75 0QR, Scotland
Tel: (44) 1355-803-000
Fax: (44) 1355-242-743

RF/Automotive

Theresienstrasse 2
Postfach 3535
74025 Heilbronn, Germany
Tel: (49) 71-31-67-0
Fax: (49) 71-31-67-2340

1150 East Cheyenne Mtn. Blvd.
Colorado Springs, CO 80906
Tel: 1(719) 576-3300
Fax: 1(719) 540-1759

Biometrics/Imaging/Hi-Rel MPU/ High Speed Converters/RF Datacom

Avenue de Rochepleine
BP 123
38521 Saint-Egreve Cedex, France
Tel: (33) 4-76-58-30-00
Fax: (33) 4-76-58-34-80

e-mail

literature@atmel.com

Web Site

<http://www.atmel.com>

Disclaimer: Atmel Corporation makes no warranty for the use of its products, other than those expressly contained in the Company's standard warranty which is detailed in Atmel's Terms and Conditions located on the Company's web site. The Company assumes no responsibility for any errors which may appear in this document, reserves the right to change devices or specifications detailed herein at any time without notice, and does not make any commitment to update the information contained herein. No licenses to patents or other intellectual property of Atmel are granted by the Company in connection with the sale of Atmel products, expressly or by implication. Atmel's products are not authorized for use as critical components in life support devices or systems.

© Atmel Corporation 2003. All rights reserved. Atmel® and combinations thereof are registered trademarks of Atmel Corporation or its subsidiaries. Other terms and product names may be the trademarks of others.



Printed on recycled paper.

0971F-SMEM-08/03